

FYH UCFL213 bearing units

Bearing No. UCFL213

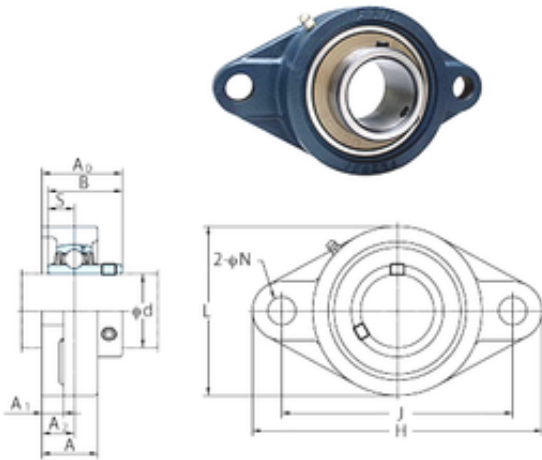

UCFL213 Bearing 2D drawings and 3D CAD models

Bore Diameter	65 mm
d	65 mm
A0	69,7 mm
A	50 mm
A1	20 mm
B	65,1 mm
H	258 mm
J	210 mm
L	155 mm
N	23 mm
S	25,4 mm
Bolt (G)	14,4
Bolt (G)	M20
A2	30 mm
Weight	5,1 Kg
Basic static load rating (C0)	57,2 kN
Category	Mounted Units & Inserts
Inventory	0.0
Manufacturer Name	FYH BEARING UNITS
Minimum Buy Quantity	N/A
Weight / Kilogram	0
Product Group	M06110