

FYH UCP206-18 bearing units

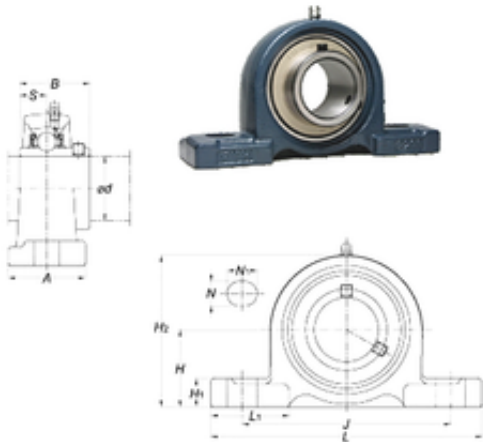

Bearing No. UCP206-18

Bore Diameter	28,575 mm
Width	38,1 mm
d	28,575 mm
A	48 mm
B	38,1 mm
H	42,9 mm
H1	15 mm
H2	84 mm
J	121 mm
L	165 mm
L1	53 mm
N	17 mm
N1	21 mm
S	15,9 mm
Bolt (G)	M14
Weight	1,3 Kg
Basic dynamic load rating (C)	19,5 kN
Basic static load rating (C0)	11,3 kN

UCP206-18 Bearing 2D drawings and 3D CAD models